

Cat. No. 16-549/550/632
OWNER'S MANUAL

Please read before using this equipment.

4-HEAD VHS HQ VCR

Model 112 (16-549)
Model 113 (16-550)
Model 62 (Hi-Fi) (16-632)

OPTIMUS®

IMPORTANT SAFETY INSTRUCTIONS

1. **Read instructions** — All the safety and operating instructions should be read before the appliance is operated.
2. **Retain Instructions** — The safety and operating instructions should be retained for future reference.
3. **Heed Warnings** — All warnings on the appliance and in the operating instructions should be adhered to.
4. **Follow Instructions** — All operating and use instructions should be followed.
5. **Cleaning** — Unplug the VCR from the wall outlet before cleaning it. Do not use liquid cleaners or aerosol cleaners. Use a damp cloth for cleaning.
6. **Attachments** — Do not use attachments not recommended by the VCR manufacturer as they may cause hazards.
7. **Water and Moisture** — Do not use this VCR near water — for example, near a bath tub, wash bowl, kitchen sink, or laundry tub, in a wet basement, or near a swimming pool.
8. **Accessories** — Do not place this VCR on an unstable cart, stand, tripod, bracket, or table. The VCR may fall, causing serious injury to someone and serious damage to the appliance. Use only with a cart, stand, tripod, bracket, or table recommended by the manufacturer or sold with the VCR. Any mounting of the appliance should follow the manufacturer's instructions and should use a mounting accessory recommended by the manufacturer. An appliance and cart combination should be moved with care.

Quick stops, excessive force, and uneven surfaces may cause an appliance and cart combination to overturn.



9. **Ventilation** — Slots and openings in the cabinet and the back or bottom are provided for ventilation and to ensure reliable operation of the VCR and to protect it from overheating. These openings must not be blocked or covered. The openings should never be blocked by placing the VCR on a bed, sofa, rug, or other similar surface.

This VCR should never be placed near or over a radiator or heat register. This VCR should not be placed in a built-in installation such as a bookcase or rack unless proper ventilation is provided or the manufacturer's instructions have been adhered to.

10. **Power Sources** — This VCR should be operated only from the type of power source indicated on the marking label. If you are not sure of the type of power supplied to your home, consult your appliance dealer or local power company. For VCRs intended to operate from battery power or other sources, refer to the operating instructions.
11. **Grounding and Polarization** — This VCR is equipped with a polarized alternating-current line plug (a plug having one blade wider than the other). This plug will fit into the power outlet only one way. This is a safety feature. If you are unable to insert the plug fully into the outlet, try reversing the plug. If the plug should still fail to fit, contact your electrician to replace your obsolete outlet. Do not defeat the safety purpose of the polarized plug.
12. **Power-Cord Protection** — Power-supply cords should be routed so they are not likely to be walked on or pinched by items placed upon or against them, paying particular attention to cords at plugs, convenience receptacles, and the point where they exit from the appliance.
13. **Outdoor Antenna Grounding** — If an outside antenna or cable system is connected to the VCR, be sure the antenna or cable system is grounded so as to provide some protection against voltage surges and built-up static charges.

Section 810 of the National Electrical Code, ANSI/NFPA No. 70-1984, provides information with respect to proper grounding of the mast and supporting structure, grounding of the lead-in wire to an antenna discharge unit, size of grounding conductors, location of antenna-discharge unit, connection to grounding electrodes, and requirements for the grounding electrode.

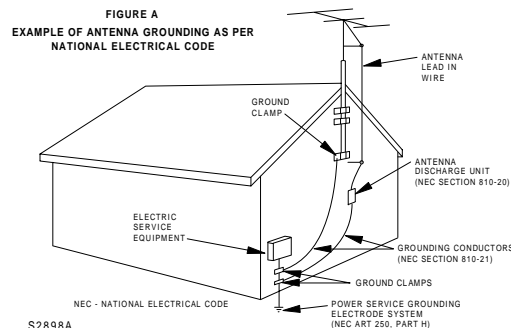

© 1997 Tandy Corporation.
All Rights Reserved.

Optimus is a registered trademark used by Tandy Corporation.
RadioShack is a trademark used by Tandy Corporation.



14. **Lightning** — For added protection for this VCR receiver during a lightning storm, or when it is left unattended and unused for long periods of time, unplug it from the wall outlet and disconnect the antenna or cable system. This will prevent damage to the VCR due to lightning and power-line surges.
15. **Power Lines** — An outside antenna system should not be located in the vicinity of overhead power lines or other electric light or power circuits, or where it can fall into such power lines or circuits. When installing an outside antenna system, extreme care should be taken to keep from touching such power lines or circuits as contact with them might be fatal.
16. **Overloading** — Do not overload wall outlets and extension cords as this can result in a risk of fire or electric shock.
17. **Object and Liquid Entry** — Never push objects of any kind into this VCR through openings as they may touch dangerous voltage points or short out parts that could result in a fire or electric shock. Never spill liquid of any kind on the VCR.
18. **Servicing** — Do not attempt to service this VCR yourself as opening or removing covers may expose you to dangerous voltage or other hazards. Refer all servicing to qualified service personnel.
19. **Damage Requiring Service** — Unplug this VCR from the wall outlet and refer servicing to qualified service personnel under the following conditions:
- When the power-supply cord or plug is damaged or frayed.
 - If liquid has been spilled or objects have fallen into the VCR.
 - If the VCR has been exposed to rain or water.
 - If the VCR does not operate normally by following the operating instructions. Adjust only those controls that are covered by the operating instructions, as improper adjustment of other controls may result in damage and will often require extensive work by a qualified technician to restore the VCR to its normal operation.
 - If the VCR has been dropped or the cabinet has been damaged.
 - When the VCR exhibits a distinct change in performance — this indicates a need for service.
20. **Replacement Parts** — When replacement parts are required, be sure the service technician has used replacement parts, specified by the manufacturer, that have the same characteristics as the original part. Unauthorized substitutions may result in fire, electric shock, injury to persons or other hazards.

21. **Safety Check** — Upon completion of any service or repairs to this VCR, ask the service technician to perform routine safety checks to determine that the VCR is in proper operating condition.
22. **Heat** — This VCR product should be situated away from heat sources such as radiators, heat registers, stoves, or other products (including amplifiers) that produce heat.

Note to the cable TV system installer:

This reminder is to call the CATV system installer's attention to Section 820-40 of the National Electrical Code, which provides guidelines for proper grounding and, in particular, specifies that the cable ground shall be connected to the grounding system of the building, as close to the point of cable entry as practical.

Warning: To reduce the risk of fire or shock hazard, do not expose this product to rain or moisture.

	CAUTION RISK OF ELECTRIC SHOCK. DO NOT OPEN.	
CAUTION: TO REDUCE THE RISK OF ELECTRIC SHOCK, DO NOT REMOVE COVER OR BACK. NO USER-SERVICEABLE PARTS INSIDE. REFER SERVICING TO QUALIFIED PERSONNEL.		



This symbol is intended to alert you to the presence of uninsulated dangerous voltage within the product's enclosure that might be of sufficient magnitude to constitute a risk of electric shock. Do not open the product's case.



This symbol is intended to inform you that important operating and maintenance instructions are included in the literature accompanying this product.

FEATURES

Your Optimus Model 112/113/62 4-Head VHS HQ VCR offers some of the most advanced features available in home video cassette recorders.

Your VCR's PLL (phase-locked loop) tuning ensures extremely accurate tuning of up to 68 VHF and UHF channels and up to 125 cable channels. The VCR's full-function universal remote control and on-screen programming make the VCR easy to use.

Your VCR offers all these features:

Note: The Model 62 includes all of the Models 112/113's features, but adds Hi-Fi stereo that delivers CD-quality sound for audio/video or audio-only recordings. The Model 62 also includes front panel audio/video jacks that make it easy to connect to a camcorder.

Easy-to-Use Immediate Recording — lets you start a recording immediately and have the VCR automatically stop recording after a length of time you select.

1-Month, 8-Event Digital Timer — lets you program the VCR to make up to eight unattended recordings (daily, weekly, or one-time).

Automatic Playback/Rewind/Eject — automatically plays, rewinds, and ejects a tape.

Fast-Response System — positions the tape next to the playback/record head for immediate playback or recording.

Real-Time Counter with Memory — displays the actual length of time a tape plays or records, and allows you to mark and return to a location on the tape.

RECORDING/PLAYBACK

26-Micron Record/Play Head — enhances the picture quality at the EP (Extended Play) playback speed.

Four Double-Azimuth Video Heads — provide superior picture quality and special effects compared with standard single-azimuth four-head VCRs.

AI (Artificial Intelligence) Video Noise Reduction System — reduces noise on the screen when playing back a worn or partially damaged tape.

Auto Tracking System — automatically adjusts tracking when you start playback.

Auto Repeat Playback — automatically rewinds the tape for repeat playback when the tape reaches the end during playback and recording.

TUNING

179-Channel, Digital-PLL, Cable-Compatible Tuner — lets you tune to up to 68 VHF and UHF channels, and up to 125 cable channels.

Tuner Memory Programming — automatically stores all the active channels in your area into memory.

TAPE CONTROL

One-Minute Skip — lets you fast-forward the tape for exactly 1 minute to let you easily skip over commercials.

Index Search — lets you quickly locate the beginning of a specific recording, or set it to automatically play the first 10 seconds of each recording so you can locate a desired recording.

Fast-Forward/Rewind with Visual Search

Freeze-Frame/Frame Advance/Slow-Motion

Automatic Rewind

OTHER FEATURES

Multichannel Television Sound (MTS) (Model 62 only) — decodes stereo broadcasts for listening or recording. This VCR can also receive and record special audio programs (SAP) that accompany some MTS broadcasts.

Rear Audio/Video Input Jacks — let you quickly connect an audio/video device to the VCR without disconnecting other devices

Front Audio/Video Input Jacks (Model 62 only) — let you quickly connect an audio/video device, such as a camcorder, to the VCR without disconnecting other devices.

Trilingual On-Screen Programming — provides helpful instructions on the TV screen for setting the clock and programming timers. You can select English, French, or Spanish instructions.

Universal Remote Control — lets you control your VCR, as well as TVs and cable boxes produced by other manufacturers.

Memory Sentinel — protects clock settings, tuner programming information, and timer memory settings in case of a power loss. The clock continues to run for 30 minutes, and tuner programming information and timer memory settings are kept for up to 24 hours.

Automatic/Manual Clock Setting — lets you set the VCR to automatically update its clock using EDS (Extended Data Service) signals sent by some TV stations. You can also manually set the clock.

Note: EDS is provided by some broadcasters and includes various types of information, including the current time. If no broadcasters in your area transmit EDS signals, you must manually set the clock.

Automatic DST (Daylight Saving Time) Adjustment — lets you set the VCR to automatically adjust the displayed time for Daylight Saving Time.

We recommend you record the VCR's model and serial numbers here. This information is on the VCR's back panel.

Model: _____

Serial Number: _____

CONTENTS

Before You Begin	8
Supplied Accessories	8
Moisture Condensation	8
Using This Manual	8
Installation	9
Common Connections	9
Model 62 Connections	10
Model 112/113 Connections	11
Home Theater Connections (Model 62 Shown)	12
Camcorder Connections	13
Connecting Power	13
VCR Setup	14
Setting the VCR'S Output Channel Switch	14
Remote Control	14
Installing Batteries	14
Using the Remote Control	14
Initial Set Up	15
Setting the On-Screen Language/Channels/Clock	15
Manually Setting the Clock	16
Turning On Auto Clock Set	17
Adding/Erasing Channels	17
Reprogramming Tuner Memory	17
Changing the On-Screen Language	18
Resetting the VCR's Memory	18
Using the VCR Remote Control with Your TV or Cable Box	19
Operation	21
Watching TV	21
Using the TV's Tuner	21
Using the VCR's Tuner	21
Viewing a Video Tape	22
Loading a Video Tape	22
Playing a Video Tape	22
Special Functions	23
Special Displays	23
Blue Screen Display	23
On-Screen Display	23
Function Indicators	23
Tape Motion Controls	23
Fast-Forward/Rewind and Visual Search	23
Freeze-Frame/Frame Advance	23
Slow Motion	24
One Minute Skip	24
Real-Time Counter	24
Using the Counter	24
Using the Zero Search Function	24

Using Index Search	25
Direct Access Index Search	25
Index Scan	25
Repeat Play	25
Tracking	26
Recording	27
Recording Speeds/Tape Selection	27
Erase Protection	27
Selecting the Signal to Record	28
Receiving/Recording Stereo/SAP Broadcasts (Model 62 Only)	28
Immediate Recording	28
Recording a Program as You Watch It	28
Recording One Program on the VCR While You Watch Another on the TV	29
Automatic Timer Recording	29
Setting a Timer	30
Monitoring an Automatic Timer Recording	31
Checking/Changing Timers	31
Clearing a Timer	32
Dubbing	32
Audio-Only Recording (Model 62 Only)	33
Additional Information	34
Troubleshooting	34
Care and Maintenance	36
Servicing Your VCR	37
Cleaning the Video Heads	37
Storing Your Video Cassettes	37
Specifications	38

BEFORE YOU BEGIN

SUPPLIED ACCESSORIES

Be sure to remove these items before you store the packing material.

- Remote control
- 75-ohm coaxial cable

Depending upon your audio/video system set-up, you might need additional cables or adapters (available at your local RadioShack store). Read "Installation" on Page 9 to determine your specific needs.

MOISTURE CONDENSATION

Condensation inside the VCR can cause tape jams or video head damage. When you move the VCR from a cold area to a warmer one, let it sit for about 2 hours before you plug it in and begin operation. This allows any moisture inside the VCR to completely evaporate.

USING THIS MANUAL

This manual has these major sections:

Installation — shows you how to connect the VCR to your audio/video system.

VCR Setup — includes procedures for preparing and using the remote control, setting the on-screen programming language, setting the channels your VCR can tune, and setting the clock.

Operation — explains how to watch TV using the TV's or VCR's tuner, and load and play a video tape.

Special Functions — describes what appears on the VCR's display and the TV screen, and how to fast-forward and rewind a tape, use the VCR's special playback, display, and search features, set the tracking manually, improve playback of worn or damaged video tapes, and use index search.

Recording — describes the different recording methods.

Additional Information — includes a troubleshooting section, care and maintenance procedures, and the VCR's specifications.

We recommend you thoroughly read at least "Installation" on Page 9 and "VCR Setup" on Page 14, to be sure you correctly install and set up your VCR.

When reading through this manual, keep the following in mind:

- Some buttons on the remote control also appear on the VCR. You can use these buttons to operate the same functions. Other procedures use only the VCR's buttons, or only the remote control's.
 - Some buttons are labeled differently on the VCR and on the remote control. Since you use the remote control most often to change settings and functions, this manual refers only to the remote control's labels. Unless otherwise noted, however, you can use either the remote control's or the VCR's buttons at any time.
 - All buttons, switches, and jacks on the VCR and all buttons on the remote control are shown in **BOLD UPPERCASE** letters in this manual.
 - Information that appears on the TV screen is shown in this typeface: **PLAY**
 - Information that appears on the VCR's display is shown in this typeface: VCR
 - The VCR displays menus and options on the TV you connect it to, and other information (such as tape motion indicators, the real-time counter, etc.) on its display.
- If a menu disappears before you finish entering information, simply locate the step where you first pressed **MENU** on the remote control, then repeat that step and all steps that follow.

INSTALLATION

COMMON CONNECTIONS

Refer to the illustrations on Page 10 (Model 62) or 11 (Model 112/113) for these connections.

Note: Some connections shown in this section might require additional supplies, available from your local RadioShack store.

b Connect the VCR to your TV for playback. You can connect (choose one):

- Your VCR's **OUT TO TV** jack to your TV's antenna jack, using a 75-ohm coaxial cable

Caution: Never connect the VCR's **OUT TO TV** jack to a terminal that has an antenna already connected. Doing so can interfere with other receivers.

- Your VCR's **OUT TO TV** jack to your TV's separate VHF/UHF antenna jacks, using a 75-ohm coaxial cable and a VHF/UHF splitter/combiner
- Your VCR's **AUDIO/VIDEO OUT** jacks to your TV's audio/video jacks, using a stereo audio/video cable

Note: For the best quality recordings, use high-quality A/V cables to make these connections.

À Connect a signal source to the VCR for recording. You can connect (choose one):

- An outside antenna, using a 75-ohm coaxial cable, to the VCR's **IN FROM ANT** jack
- An outside antenna, using 300-ohm lead-in wire and a 300-to-75 ohm transformer, to the VCR's **IN FROM ANT** jack
- Your CATV (cable) source, using the 75-ohm coaxial cable directly from the cable company, to the VCR's **IN FROM ANT** jack

Caution: Some state laws restrict direct connections to cable wires (connections that do not go through a cable box). Check the laws in your area before you make connections.

- A cable converter box to the VCR's **IN FROM ANT** jack

Note: There are many cable TV systems in use. If you subscribe to cable TV service and cannot record cable TV programs, contact your local cable TV service provider. Most cable TV service providers offer connection help.

Ã You can also connect an optional video source, such as a camcorder, another VCR, or a DSS system to your VCR using A/V cables. Simply connect it as shown.

Connection Notes:

- You can connect two video sources (three sources for the Model 62) directly to your VCR. To do so, you connect one source to the **AUDIO IN 1/VIDEO IN 1** jacks on the back of the VCR using A/V cables and the other to the **IN FROM ANT** jack using a 75-ohm coaxial cable (and, with the Model 62, another source to the **AV2 AUDIO/VIDEO IN** jacks on the front of the VCR, see "Camcorder Connections" on Page 13).
- You can connect additional 75-ohm coaxial sources to your system using a high-isolation A/B switch to switch between the sources.
- You can connect one 75-ohm coaxial source to more than one device using a video splitter.

Because of the complexity of the variations possible when using additional video accessories, such as video signal switches, splitters, and combiners, such configurations are not shown in this manual.

MODEL 62 CONNECTIONS

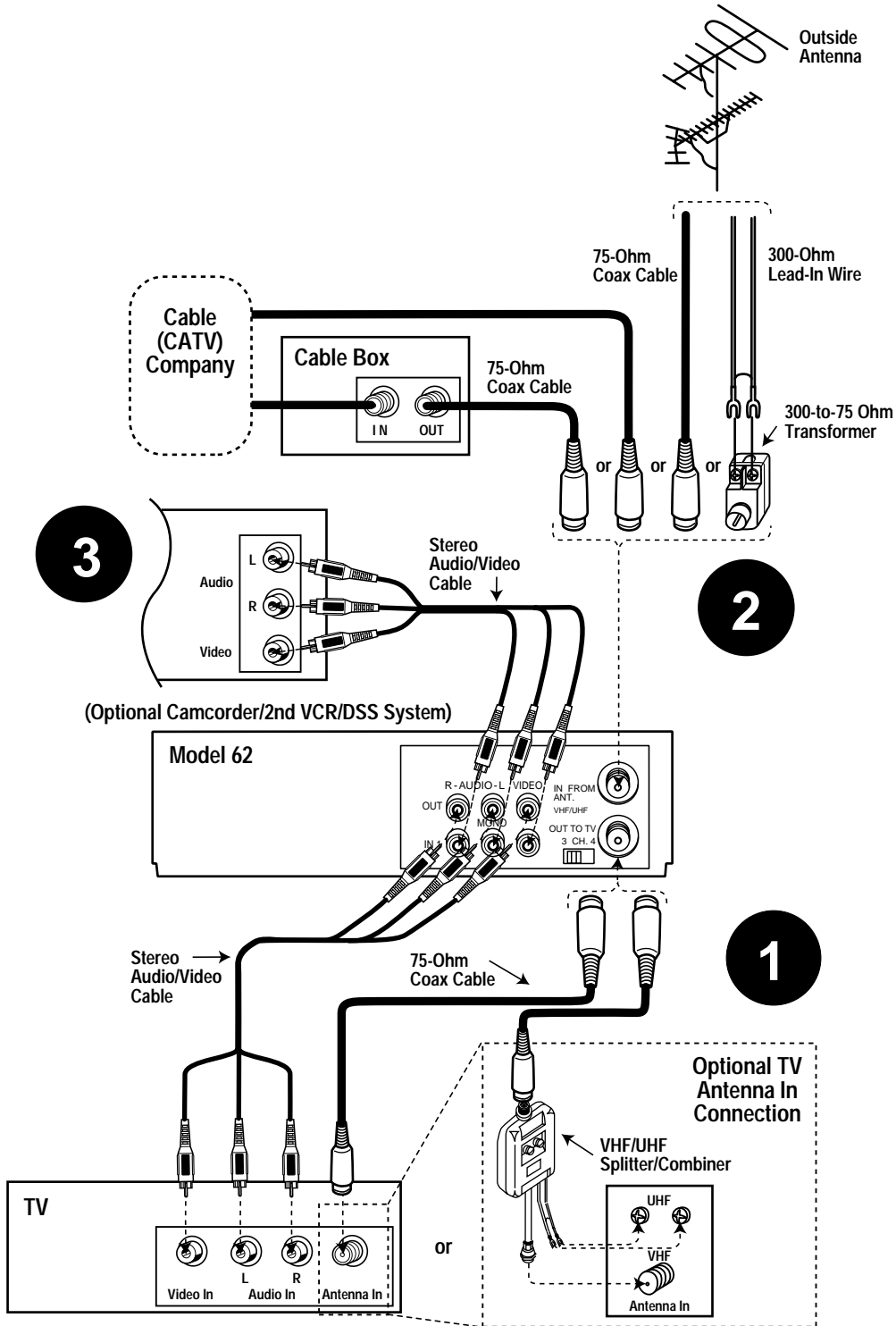

MODEL 112/113 CONNECTIONS

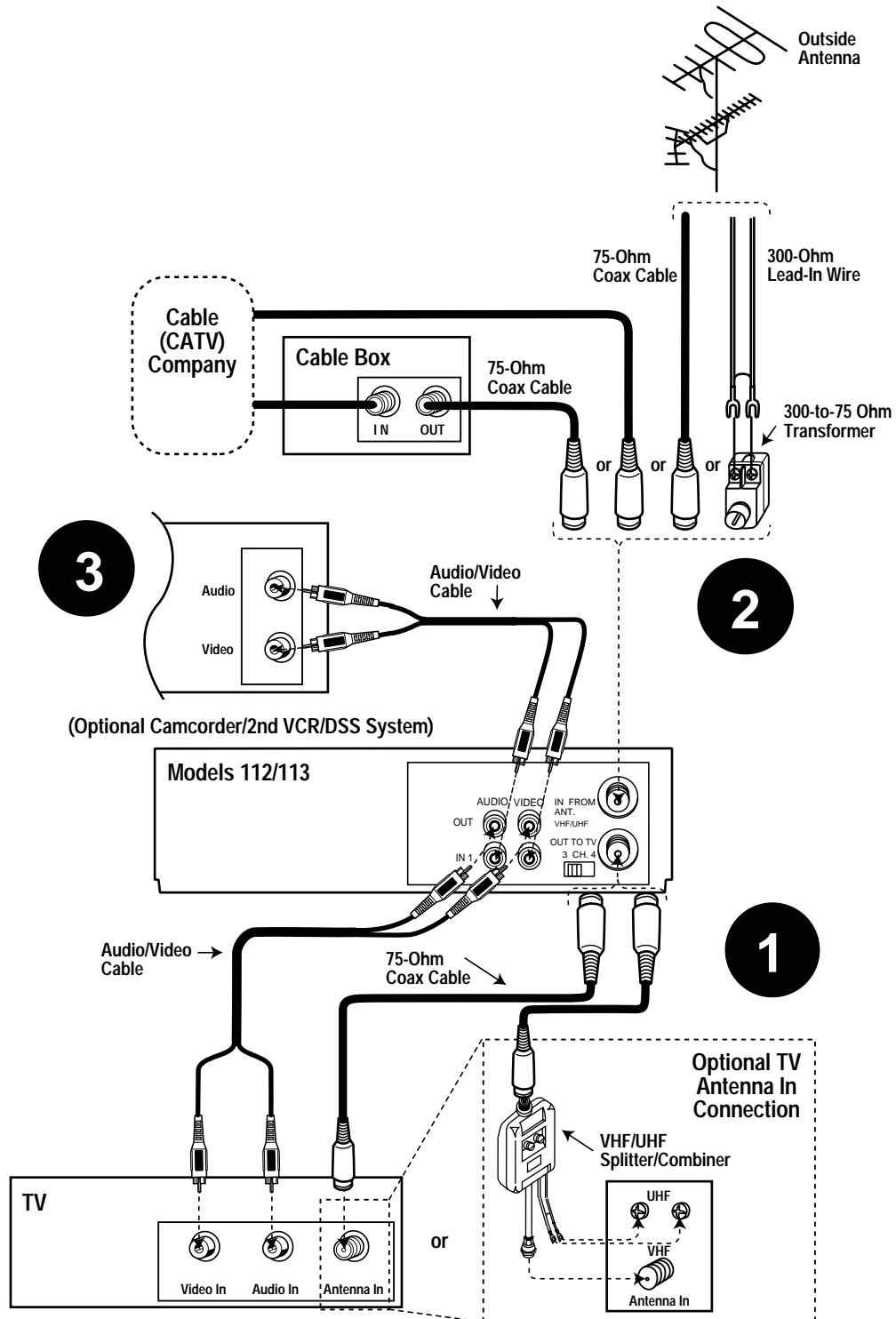

HOME THEATER CONNECTIONS (MODEL 62 SHOWN)

Refer to this illustration to connect your VCR to a home theater system.

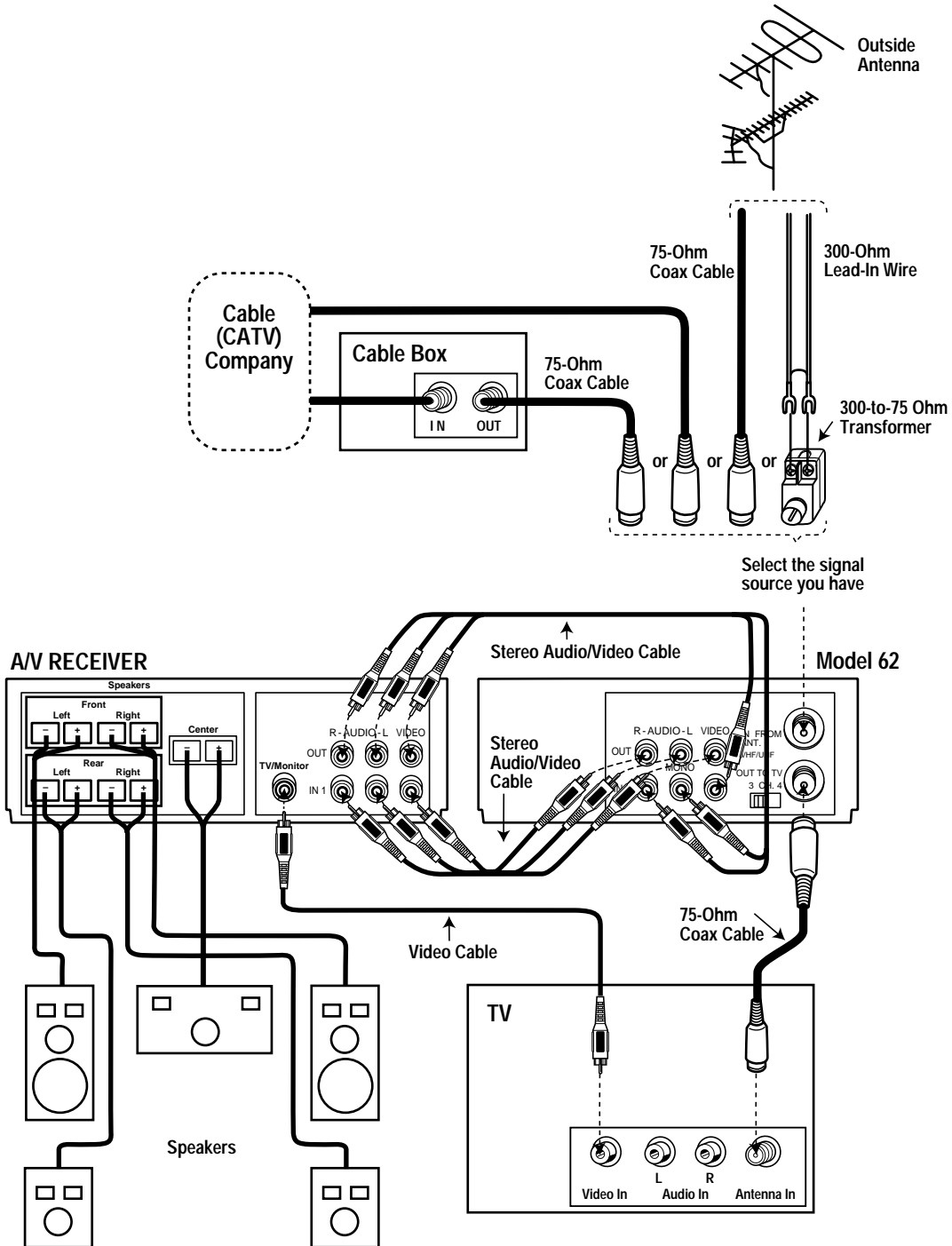

CAMCORDER CONNECTIONS

Your Model 62 VCR has jacks on its front panel that let you easily connect a camcorder or other video source. You can also connect a camcorder to the **AUDIO IN** and **VIDEO IN** jacks on the back panel of your Model 112/113 VCR.

You need a stereo A/V cable (not supplied) with plugs that fit the VCR's jacks and the camcorder's jacks for this connection.

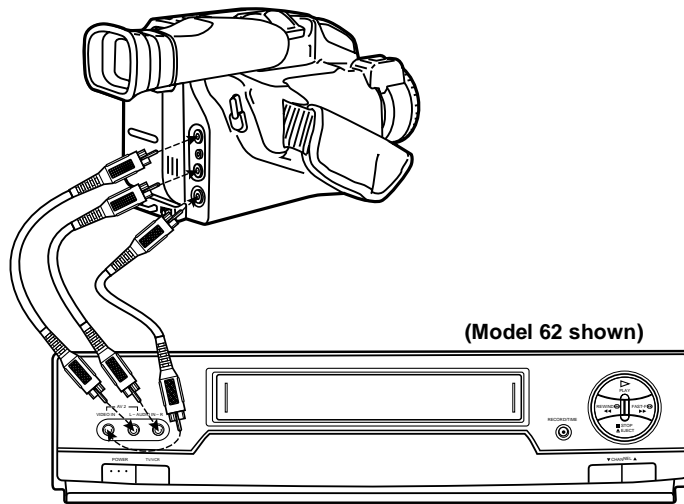

1. Insert the plugs at one end of the cable into the **AV 2 AUDIO** and **VIDEO IN** jacks on the Model 62's front panel.
2. Insert the plugs at the other end of the cable into the AUDIO/VIDEO OUT jacks on your camcorder or other video source. Be sure to connect VIDEO to VIDEO and AUDIO to AUDIO (use the plug's color codes as a guide).

CONNECTING POWER

To power the VCR, plug its power cord into a standard AC outlet. --:-- appears on the display.

Note: The VCR starts to search for a channel that has an Extended Data Service (EDS) signal (see "Turning On Auto Clock Set" on Page 17) when:

- You plug in the VCR for the first time.
- You unplug the VCR and reconnect it (within 24 hours) or after a power failure (of less than 24 hours).
- You reset the VCR's memory (see "Resetting the VCR's Memory" on Page 18).

VCR SETUP

SETTING THE VCR'S OUTPUT CHANNEL SWITCH

If you connected the VCR's **OUT TO TV** terminal to a TV or another VCR, set **3-CH-4** on the back of the VCR to **3** or **4**, whichever is not an active channel in your area.

When VCR appears on the display, the VCR sends the signal from the video source connected to its **IN FROM ANTENNA** or **AUDIO IN 1 / VIDEO IN 1** (or **AV2** for the Model 62) terminals to the TV on the channel you selected.

Note: Setting **3-CH-4** has no effect on the TV when the VCR is off or if you connected a TV with separate audio/video input jacks to the VCR's **AUDIO 1/VIDEO 1 OUT** jacks.

- Put fresh batteries in the compartment, as indicated by the polarity symbols (+ and -) marked inside.

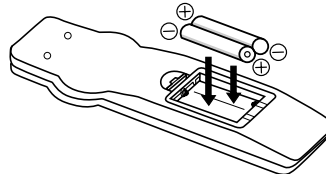

- Replace the cover.

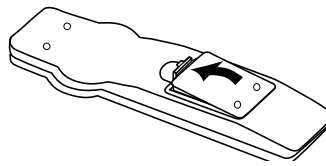

Note: When the remote control stops working or operates poorly, replace both batteries.

Cautions:

- Never leave dead or weak batteries in the remote control. Batteries can leak chemicals that can damage your remote control.
- Dispose of dead batteries promptly and properly; do not bury or burn them.

REMOTE CONTROL

Installing Batteries

The remote control requires two AA batteries (not supplied). For the longest operation and best performance, we recommend alkaline batteries (such as RadioShack Cat. No. 23-557).

Cautions:

- Use only fresh batteries of the required size and type.
- Do not mix old and new batteries, different types of batteries (standard, alkaline, or rechargeable), or rechargeable batteries of different capacities.

- Press the tab on the battery compartment cover and lift off the cover in the direction of the arrow.

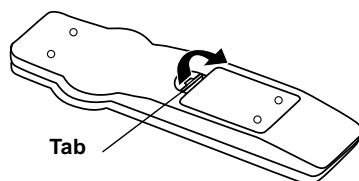

Using the Remote Control

To use the remote control, aim it at the front of the VCR and press the desired function buttons.

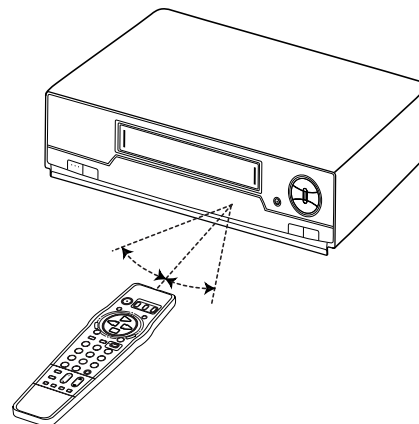

INITIAL SET UP

Setting the On-Screen Language/ Channels/Clock

When you first plug in the VCR and turn it on, when you turn it on after power was interrupted for longer than 24 hours, or when you reset the VCR's memory, the VCR prompts you to select a language, then scans for active channels in your area and stores them.

In many areas, the Public Broadcasting Service (PBS) station broadcasts an electronic data signal (EDS) with its regular broadcast. This signal can automatically set your VCR's clock to the correct time. If a station in your area has EDS signals, the VCR automatically sets the clock.

Notes:

- The VCR is preset to automatically set the clock, but you can change it. See "Turning On Auto Clock Set" on Page 17.
- If no stations in your area broadcast EDS signals, you can set the clock manually. See "Manually Setting the Clock" on Page 16 for more information.

1. Press **POWER** to turn on the VCR.
2. Turn on your TV and set it to the same channel as the VCR's **3-CH-4** switch or select its line input if you connected the VCR to the TV's audio/video input jacks. Then press **TV/VCR** so VCR appears.
3. Select the on-screen instruction language: press **CH s** for English, **CH t** for Spanish, or **TV/VCR** for French.

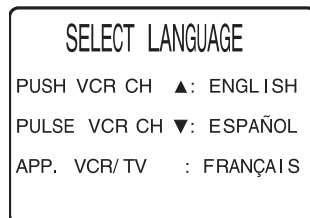

4. When the following appears on the TV screen, set it to the local PBS station if you have a cable box, then press **CH s**. (If you do not have a cable box, simply press **CH s**).

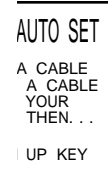

After you press **CH s**, the VCR scans through the channels and memorizes all the active channels in your area.

Note: If you have already set the channels and just want to manually set the clock, press **MENU** to skip tuner programming. Then see "Manually Setting the Clock" on Page 16 to set the clock.

5. When the VCR finishes scanning and storing channels, it searches for an EDS signal and shows the following on the TV screen:

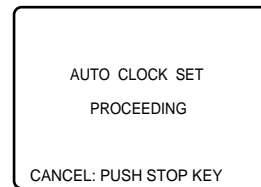

It takes up to 10 minutes for the VCR to set the clock using the EDS signal. If the VCR finds an EDS signal, it automatically sets its clock to the correct time.

If the VCR does not detect an EDS signal within this time, press **STOP** then see "Manually Setting the Clock" on Page 16 to set the clock.

Notes:

- Your VCR protects tuner programming for up to 24 hours in case a power failure occurs or if the power cord becomes unplugged. After about 24 hours without power, the VCR loses the tuner programming.

- If you have not connected the VCR to an antenna, cable TV, or other signal source through the **IN FROM ANT** terminal, the VCR does not store any channel in memory. Instead, the VCR displays the following on the TV screen:

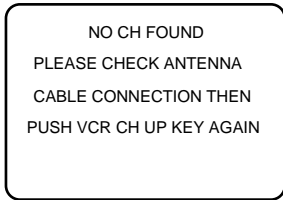

Manually Setting the Clock

Follow these steps to manually set the clock if EDS is not available in your area, or if you skipped tuner programming.

Notes:

- The clock must be accurately set for proper automatic timer recording. We suggest you refer to a radio station or time/temperature service for the correct time.
- If you do not press a button within 5 minutes in Steps 2–9, the clock is not set. Start again from Step 1

1. Press **MENU** to display the main menu.
Note: To exit the programming mode, press **MENU** again at any time.
2. Repeatedly press **▶ PLAY** or **■ STOP** to highlight **SET CLOCK**, then press **▶▶ FAST-F**.
3. Repeatedly press **PLAY** or **STOP** to highlight **MANUAL SET**, then press **FAST-F**.



4. Repeatedly press **PLAY** or **STOP** to select the correct month, then press **FAST-F**.



5. Repeatedly press **PLAY** or **STOP** to select the correct date, then press **FAST-F**.
6. Repeat Step 5 to select the correct year and the correct hour, then press **FAST-F**.

Note: Your VCR uses a 12-hour clock. Be sure you correctly set AM or PM.

7. Repeatedly press **PLAY** or **STOP** to select a minute that is 1 or 2 minutes after the current time, then press **FAST-F**. (For example, if it is 42 minutes past the hour right now, enter 43 minutes now.) This gives you time to complete this procedure before starting the clock.
8. Repeatedly press **PLAY** or **STOP** to set **DST** (daylight saving time) to **ON** or **OFF**.

When you set **DST** to **ON**, the VCR automatically adds 1 hour on the first Sunday in April, and subtracts 1 hour on the last Sunday in October.

Press **FAST-F**. **SET COMPLETED** appears.

9. Review the information you entered.



If the information is not correct, move the cursor to the incorrect entry by repeatedly pressing **◀◀ REW** or **FAST-F**, then enter the correct information.

When the information is correct and the time reaches the minute you set in Step 7, press **MENU** twice. The currently set time appears and the clock starts running.

Note: Seconds begin counting from 00 when you press **MENU** twice.

Turning On Auto Clock Set

If you turned off the auto clock set feature and manually set the VCR's clock, then find that EDS is available in your area, you can turn the auto clock set feature back on. This ensures that the VCR sets itself to the correct time after a power failure of less than 24 hours.

Follow these steps to turn on auto clock set.

1. Press **MENU** to display the main menu.
2. Repeatedly press **PLAY** or **STOP** to highlight **SET CLOCK**, then press **FAST-F**.
3. Repeatedly press **PLAY** or **STOP** to highlight **AUTO SET**, then press **FAST-F**.

```

K -----
|
| ET
|
Y _____

```

4. Press **CH s**. The VCR searches for an EDS signal and, if it finds one, automatically sets its clock to the correct time. If the VCR does not find an EDS signal, follow the steps under "Manually Setting the Clock" on Page 16.

Adding/Erasing Channels

We recommend you check the channels the VCR automatically stored. It might have stored distant, weak channels that you normally would not watch, or it might have missed channels you want to store.

If the tuner stores a channel that you do not want, repeatedly press (or press and hold) **CH s** or **CH t** to tune to that channel, then press **ADD/HLT**. **CHANNEL nn DELETED** appears, and the unwanted channel is erased from the tuner's memory.

CHANNEL 08 DELETED

If you want to program a weak channel that automatic programming missed, enter the desired channel number using the remote control's number buttons. Then press **ADD/HLT**. **CHANNEL nn ADDED** appears, and the channel is added to memory.

CHANNEL 08 ADDED

Reprogramming Tuner Memory

You might want to reprogram the VCR's tuner memory if you move or change from an antenna connection to a cable TV connection.

Note: You can also quickly erase all settings, including the time, local channels, and programmed events, then reprogram the tuner's memory. See "Resetting the VCR's Memory" on Page 18.

Follow these steps to reprogram the tuner.

1. Press **MENU** to display the main menu.

Note: To exit the programming mode during Steps 2–4, press **MENU** again.

2. Repeatedly press **PLAY** or **STOP** to highlight **SET UP CHANNEL**, then press **FAST-F**.



English

3. Press **FAST-F** again to select the broadcast system (**TV** or **CATV**).

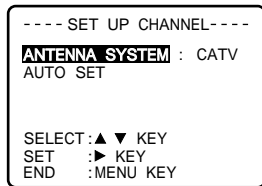

Espanol

4. Press **STOP** to highlight **AUTO SET**, then press **FAST-F**.

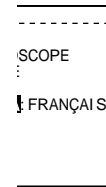

Français

5. Press **CH s**. The VCR starts scanning for and storing active channels.

3. Press **FAST-F** so the desired language appears next to the fourth item.

4. When you finish selecting the language you want, press **MENU**.

Changing the On-Screen Language

The on-screen programming language is pre-set to English, but you can change it at any time by following these steps.

1. Press **MENU** to display the main menu.
2. Repeatedly press **PLAY** or **STOP** to highlight the fourth menu selection, then press **FAST-F**. The title of the fourth menu selection differs depending on the language currently selected.

Resetting the VCR's Memory

If at any time you want to erase all settings, including the time, local channels, and programmed events, eject any loaded tape, then hold down **PLAY** and **CHANNEL s** on the VCR for about 5 seconds until it turns itself off. All settings are cleared.

The next time you turn on the VCR, it performs its initial setup sequence. See "Setting the On-Screen Language/Channels/Clock" on Page 15.

USING THE VCR REMOTE CONTROL WITH YOUR TV OR CABLE BOX

In addition to controlling your VCR, the remote control can operate the basic functions of your TV and cable box. Follow these steps to program the remote control with the correct manufacturer's code number for that TV and cable box.

Note: Some brands have more than one code listed in the charts. If a code does not work with your TV or cable box, try another. The listed codes might not work with all models from the listed manufacturers.

1. Find the code for your TV and cable box in the following charts.

TV BRAND	CODE
Fisher	10
GE	03
Goldstar	15, 16, 17
Hitachi	12
JVC	11
Magnavox	05
Mitsubishi	07, 13
Panasonic	01, 02
Quasar	01, 02
RadioShack	01, 02, 15, 16, 17
RCA	03
Realistic	01, 02, 15, 16, 17
Samsung	14
Sanyo	10
Sharp	06, 07
Sony	08
Sylvania	05
Toshiba	09
Zenith	04

CABLE BOX BRAND	CODE
Archer	01, 29, 44, 88, 91
Cableview	04, 30, 42, 44, 52, 63, 85, 88
Citizen	04, 30, 42, 44, 52, 63, 85, 88
Curtis	08, 09, 56, 61, 87, 90
Diamond	01, 29, 44, 88, 91
Drake	37, 67, 71
Eagle	13, 20, 22, 26, 40, 58, 62, 98
Eastern	28
GC Brand	04, 30, 42, 44, 52, 63, 85, 88
Gemini Regal	04, 85
General Electric	57
General Instrument	01, 02, 03, 04, 34, 55, 83, 85, 91, 93, 95
Hamlin	14, 15, 28, 41, 97, 100, 102
Hitachi	31, 79
Jerrold	01, 02, 03, 04, 34, 55, 83, 85, 91, 93, 95
Macom	31, 79
Magnavox	25, 26
Matsushita	16, 17, 101
Movietime	29, 32, 38, 39, 40, 42, 44, 88
NSC	32, 38, 40
Oak	10, 11, 46, 99
Optimus	44, 88
Panasonic	16, 17, 101
Philips	13, 20, 23, 24, 96
Pioneer	05, 06, 78
Pulsar	04, 30, 42, 44, 52, 63, 85, 88
RadioShack	44, 88
RCA	16, 17, 101

CABLE BOX BRAND	CODE
Realistic	44, 51, 88
Regal	14, 41
Regency	28
Rembrandt	29, 32, 39, 42, 44, 88
Samsung	32, 40, 42, 78, 94
Scientific Atlanta	08, 09, 56, 61, 87, 90
Sheritech	27
SL Marx	32, 40, 42, 78, 94
Sprucer	16, 17, 101
Stargate	04, 30, 32, 40, 42, 44, 52, 63, 78, 85, 88, 94
Sylvania	19
Teknika	74
Telecaption	77, 92
Televiuew	32, 40, 42, 78, 94
Texscan	18, 19
Tocom	01, 33, 34, 42, 48, 49, 91
Toshiba	36
Uniden Satellite	65, 69
Unika	01, 29, 44, 88, 91
Universal	42, 43, 44, 52, 63, 88
Viewstar	13, 20, 22, 26, 40, 58, 62, 98
Videoway	07, 23, 50
Vid Tech	64
Vidter	64
Zenith	07, 23, 50

2. While holding down **TV**, enter the code number for your TV using the number buttons. Or, while holding down **CATV**, enter the code number for your cable box using the numbered buttons.

Precede a single-digit code number with a 0 — for example, 01, 02, etc. To enter a three-digit number, press **100**, then enter

the second and third digits in the code number.

3. Try operating your TV or cable box using the VCR's remote control. First press **TV** or **CATV**, then try pressing **POWER**, **INPUT**, **CH s** or **CH t**, and **VOL +/-** for TV operation; or **POWER** and **CH s** or **CH t** for cable box operation.

If the device does not function, repeat Step 2 and try other codes for the manufacturer. If it still does not function, you must use the original remote control supplied with your TV or cable box.

To use the remote control, press the button for the device you want to control — **TV**, **CATV**, or **VCR**. Then press the desired function button.

Notes:

- The codes you programmed might be erased if you remove the batteries from the remote control (to replace them, for example). If this happens, re-enter the codes after you replace the batteries.
- Some TVs and cable boxes might require that you manually turn on the power for that device.
- Your TV or cable box might have functions that the VCR's remote control will not operate.
- You can use the number buttons to select a channel number on your TV and cable box. However, some TVs/cable boxes might require that you press **DISP/ENT** after entering the channel number.
- **VOL +/-** works to adjust the TV volume in any operation mode (VCR, TV, or CATV).

OPERATION

WATCHING TV

Using the TV's Tuner

To watch a broadcast using the TV's tuner, turn off the VCR, or repeatedly press **TV/VCR** until VCR disappears from the VCR's display.

Note: If you are using a TV/monitor connected to the VCR's **AUDIO/VIDEO OUT** jacks, be sure to set the TV/monitor to the TV mode.

The antenna or cable signals pass through the VCR unaffected, as if the antenna or cable were connected directly to the TV. Use the TV as you normally would.

Using the VCR's Tuner

Your VCR can receive up to 68 VHF and UHF channels, and up to 125 cable channels. The VCR displays the channels as 1–125.

Notes:

- Channels 2–13 are the same for VHF and cable TV, and cable companies usually number them as they appear on the display.
- Since cable companies sometimes designate cable channels with letters or letter-number combinations, a channel number you see on the VCR's display might differ from the channel number displayed on your cable box. You might need to experiment to determine the proper cable channel designations for your cable system. For more information, contact your local cable company.
- Two of the cable channels are designated for audio only.

1. Turn on the TV and set it to the same channel as the VCR's **3-CH-4** switch.

Note: If you are using a TV/monitor connected to the VCR's **AUDIO/VIDEO OUT** jacks, set the TV/monitor to the video mode.

2. Repeatedly press **TV/VCR** until VCR appears.
3. To manually select a channel, you can press **CH s** or **CH t** to have the tuner automatically advance to the next channel stored in the tuner's memory.

Note: If you press **CH s** when the tuner is at the highest programmed channel or **CH t** when the tuner is at the lowest programmed channel, the VCR enters the audio/video mode and **LINE** (**LINE 1** or **LINE 2** on the Model 62) appears on the TV (see "Selecting the Signal to Record" on Page 28). Continue to press **CH s** or **CH t** until the highest or lowest programmed channel appears.

Or, to directly select a channel, press the number buttons on the remote control for the desired channel.

Notes:

- Precede a single-digit number with a 0 — for example, 01, 02, and so on.
- To enter a three-digit number, press **100**, then enter the second and third digits in the channel number.
- (Model 62 only) If you receive MTS stereo or SAP broadcasts, see "Receiving/Recording Stereo/SAP Broadcasts (Model 62 Only)" on Page 28.

VIEWING A VIDEO TAPE

Loading a Video Tape

1. Turn on the TV and set it to the same channel as the VCR's **3-CH-4** switch.

Note: If you are using a TV/monitor that is connected to the VCR's **AUDIO/VIDEO OUT** jacks, set the TV/monitor to the video mode.

2. Hold the cassette with the main label facing up and the spine facing out from the VCR. Then insert the cassette into the VCR's compartment and gently push the center of its spine until the VCR draws it in.

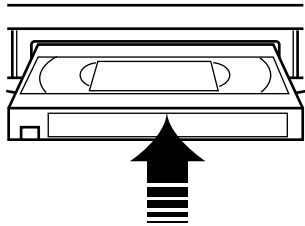

The VCR automatically turns on. If the erase-protection tab has been removed from the cassette, playback automatically begins (see "Erase Protection" on Page 27).

Caution: Never insert anything except a VHS video cassette into the cassette compartment. Anything else might damage the VCR.

Playing a Video Tape

1. Load a video tape.
2. If playback does not automatically begin, press **PLAY**. The VCR plays the tape.

Notes:

- The following appears on the TV screen when you press **PLAY**, **REW**, **FAST-F**, or **REC/TIME** without inserting a cassette.

NO CASSETTE
PLEASE INSERT A CASSETTE

- During playback, the VCR automatically adjusts tracking, but you can manually adjust it if necessary (see "Tracking" on Page 26).
3. (Model 62 only) To choose the type of audio you want the Model 62 to play back, press **SAP/HiFi** until an arrow appears next to the desired audio mode indicator (**HiFi** or **NORMAL**) on the TV screen.

Note: If you play a tape recorded on a standard VCR, the Model 62 plays the standard audio track, regardless of the audio output setting.
 4. To stop playback before the end of the tape, press **STOP**.
 5. To eject the tape, press **STOP EJECT** on the VCR.

Notes:

- If the tape reaches the end before you press **STOP** or **STOP EJECT**, the VCR automatically stops the tape and completely rewinds it. If the erase-protection tab has been removed, the VCR then ejects the cassette.
- When the VCR is off, you can press **STOP EJECT** on the VCR to eject a tape. The VCR turns on, ejects the tape, then turns itself off.

SPECIAL FUNCTIONS

SPECIAL DISPLAYS

Blue Screen Display

The VCR displays a blue screen on the TV when you select the VCR mode, play unrecorded portions of a tape, or when you tune to a weak TV station. The blue screen also appears if you set the VCR to the audio/video mode when the **AUDIO/VIDEO IN** jacks are not receiving any signals.

Note: You cannot record the blue screen on a tape in the VCR.

On-Screen Display

To view your VCR's current operating mode and other information about your VCR, press **DISP/ENT** (display/enter). If you have a Model 62, you see the broadcast type (**STEREO**, **SAP**, or **MONO**). With all models, you also see the current function, time, channel, counter, and tape speed. Press **DISP/ENT** again to clear the display.

Note: You also see the remaining recording time while a timed recording is in progress (see "Immediate Recording" on Page 28).

Function Indicators

When you press a function button (such as **STOP**), the selected function's indicator (such as **STOP**) appears on the TV screen for about 4 seconds. When you change the channel, the new channel number appears on the TV screen for about 4 seconds.

Note: If you play back a poor quality or damaged tape, the function indicator might not appear.

TAPE MOTION CONTROLS

Fast-Forward/Rewind and Visual Search

While a tape is stopped, press **FAST-F** to advance the tape quickly or **REW** to rewind it. You cannot see the picture or hear sound when you use fast-forward or rewind, but you can use the counter to locate a specific section of tape.

Note: If you press **POWER** while a tape is rewinding, **REWIND ► POWER OFF** appears. The VCR automatically turns itself off when rewinding is complete.

To use visual search so you can see the picture, be sure VCR appears then begin tape playback. Then press **FAST-F** to search forward or **REW** to search in reverse. Press **PLAY** to return to normal playback. During visual search, the sound is muted and the picture quality is lower than during normal playback. The search picture is best with tapes recorded at the SP or EP speed.

Freeze-Frame/Frame Advance

Freeze-frame lets you pause the tape to view a single frame. Press **PAUSE** during playback to freeze the picture. Press **PAUSE** again or **PLAY** to return to normal playback.

During freeze-frame, picture quality is lower than during normal playback. The picture quality is best with recordings made at the SP or EP speed (see "Recording Speeds/Tape Selection" on Page 27).

Notes:

- If you leave the VCR in the freeze-frame mode for 3 minutes, the VCR stops playing the tape to protect the video heads.
- To reduce or eliminate jitter in the freeze-frame picture, press and hold **CH s** or **CH t** until the picture is clear.

During freeze-frame, you can advance the picture one frame at a time by repeatedly pressing **SLOW**. This feature works best with video cassettes recorded at the SP or EP speed. Press **PAUSE** to return to normal playback.

Slow Motion

To start slow motion playback, while a tape is playing, press **SLOW**. Press **SLOW** again or **PLAY** to return to normal playback. During slow motion, the sound is muted and the picture quality is lower than during normal playback. Slow motion picture quality is best with tapes recorded at the SP or EP speed.

Notes:

- If you leave the VCR in the slow-motion mode for 3 minutes, the VCR stops playing the tape to protect the video heads.
- If the slow-motion picture is poor, press and hold **CH s** or **CH t** until the picture improves.

One Minute Skip

You can skip over unwanted material on the recorded tape, such as commercials. Press **ZERO/1MIN** during playback. The VCR fast forwards over the next minute of recording, then resumes normal playback.

REAL-TIME COUNTER**Using the Counter**

Your VCR's counter shows how long a tape has been running. To have the counter display on the TV screen, press **DISP/ENT** on the remote control.

The counter does not reset if you eject a tape then put in a new tape. To reset the counter to **0:00:00**, press **COUNTER RESET**.

Note: The real-time counter might stop if you fast-forward or rewind through a blank section on the tape. This is normal.

Using the Zero Search Function

You can reset the counter to **0:00:00** at any position on the tape and then return to that position. This lets you quickly return to a selected place on the tape later.

Follow these steps to use the zero search function.

1. While a tape is playing, if the counter does not appear on the TV screen, press **COUNTER RESET** once to display it.
2. Within 5 seconds, press **COUNTER RESET** again at the location you want to return to later. The counter resets to **0:00:00**.
3. When you want to return to the selected location, stop the tape, then press **ZERO/1MIN**. The tape rewinds or fast-forwards and automatically stops when it reaches **0:00:00**.

Notes:

- If you press **REW** to rewind the tape past **0:00:00**, the time appears with a minus (-) sign.
- The counter does not work with blank tapes or blank portions of partially recorded tapes.

USING INDEX SEARCH

Your VCR has the VHS Index Search System. Each time you start recording, the VCR automatically marks the tape with an index mark at that location. You can locate the recording you want to play or skip the recording(s) you don't want to watch by either entering the number of index marks or by scanning. The VCR searches forward or backward from the current location.

Notes:

- Since the VCR does not display the index marks, we recommend you list the recordings on each tape in order on the tape's box, to make it easier to locate a particular recording on the tape.
- Index search might not function properly when two or more index marks are close to each other.
- If you do not press any button within 10 seconds after you select **INDEX**, the VCR cancels index search mode.
- If you activate the direct access index search at a tape position very close to an index mark, the VCR might not count that mark. See "Direct Access Index Search."
- Recording over an index mark erases that index mark.

Direct Access Index Search

While the VCR is stopped or playing a tape, press **INDEX**. **INDEX** appears. Then use the number keys to enter the number of index marks you want to skip.

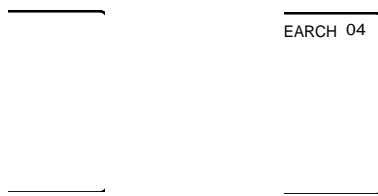

For example, if the tape is at the second recording (index mark 2) and you want to watch the seventh recording (at index mark 7), enter **5** to skip past index marks 3 through 6. Or, if the tape is at index mark 9 and you want to watch the recording at index mark 3, enter **7** to skip past index marks 9 through 4.

Then press **FAST-F** to skip forward to that index mark or **REW** to skip backward. When the tape reaches the selected index mark, the VCR starts normal playback.

Index Scan

While the VCR is stopped or playing a tape, press **INDEX**. **INDEX** appears. Then press **FAST-F** or **REW** to start the scan. **AUTO INDEX SEARCH** appears and the VCR starts to fast-forward or rewind. As the tape passes an index mark, the VCR enters the visual search mode for 10 seconds, then resumes the fast-forward or rewind.

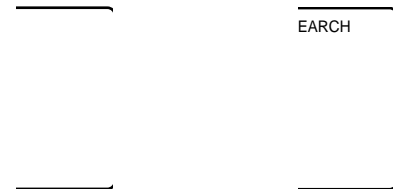

When you locate the recording you want, press **PLAY**. Normal playback starts.

REPEAT PLAY

You can automatically repeat playback of a tape from the beginning to the end (or to a blank part), instead of having the tape automatically rewind and eject.

1. While the tape is stopped, press **MENU** to display the main menu.
2. Press **PLAY** or **STOP** to highlight **SET UP VCR**, then press **FAST-F**. The VCR highlights **REPEAT PLAY**.

3. Press **FAST-F** so **ON** appears.

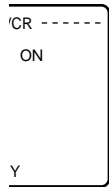

4. When you finish setting the repeat play option, press **MENU** twice.
5. Press **PLAY** to start repeat playback. **REP** appears.

The VCR repeats playback from the beginning to the end of the tape, or to the first unrecorded portion that is at least 30 seconds long. **AUTO REPEAT** appears while the VCR rewinds the tape to the beginning.

Once you select the repeat play mode, it remains on even after you turn off the VCR. To turn off repeat play, repeat these steps and select **OFF** in Step 3.

TRACKING

The auto tracking system automatically adjusts tracking when you start playback.

When different parts of the tape are recorded at different speeds, the VCR automatically re-adjusts the tracking at the beginning of each recording.

If you need to manually adjust tracking, hold down **CH s** or **CH t**. To return to the automatic tracking system, press **CH s** and **CH t** at the same time or turn the power off then back on.

Notes:

- You might need to slightly readjust tracking for each tape you play.
- If the sound of a recording made on another VHS Hi-Fi VCR is poor, you might be able to improve it by adjusting the tracking.

Hint for Model 62 only: If the tracking is incorrect, **Hi-Fi** does not appear.

RECORDING

There are four ways to record using your VCR:

- Immediate recording — to record a broadcast as you watch it or record one program on the VCR while you watch another on the TV.
- Automatic timer recording — to record a broadcast at a time you set.
- Dubbing — to record a broadcast from another tape or video source.

Notes:

- You can set the VCR so it stops recording after a length of time you select.
- Your VCR automatically records the audio signal and adjusts the sound level while it records.
- The video cassette you use for recording must have the erase-protection tab in place. If the tab is removed, the cassette automatically ejects if you try to record on it (see "Erase Protection" on Page 27).

RECORDING SPEEDS/TAPE SELECTION

This VCR can record at three speeds: SP (standard play), LP (long play), and EP (extended play).

SP is the fastest recording speed and results in the highest quality picture. LP and EP record more slowly and use less tape, but the picture quality is not as high as a recording made at the SP speed.

The quality of tape you use greatly affects record/playback quality and the life of the VCR. Use only video cassettes that display the official **VHS** logo. High-grade tape has a better oxide coating that helps prevent dirty video heads and gives the best results.

Although T-160 video cassettes offer the longest recording time, they contain thinner tape that is more likely to jam. We suggest you use T-120 or shorter length tape.

The following chart shows the maximum recording times for different-length tapes at the recording speeds.

TAPE LENGTH	SP	LP	EP
T-60	1 hour (60 min.)	2 hours (120 min.)	3 hours (180 min.)
T-120	2 hours (120 min.)	4 hours (240 min.)	6 hours (360 min.)
T-160	2 ² / ₃ hours (160 min.)	5 ¹ / ₃ hours (320 min.)	8 hours (480 min.)

ERASE PROTECTION

Video cassettes have an erase-protection tab to prevent accidental erasure of a tape. To prevent recording, break off the tab using a screwdriver. The cassette automatically ejects if you try to record on the tape.



If you want to record on a video cassette that does not have the tab, put a piece of heavy plastic tape over the erase-protection tab hole.



SELECTING THE SIGNAL TO RECORD

You can select the signal to record — from the **IN FROM ANT** jack or an audio/video source — in either of these ways.

- Repeatedly press **INPUT** until the desired input source appears — **LINE** (**LINE 1** or **LINE 2** on the Model 62) for an audio/video source, or a channel number for broadcast signals.
- Repeatedly press **CH s** or **CH t** to set the VCR to the desired broadcast channel or to one channel higher than the highest channel number (or one channel lower than the lowest channel number) for an audio/video source.

Note: (Model 62 only) Select **LINE 1** for recording signals from the back **AUDIO IN 1/VIDEO IN 1** jacks, or **LINE 2** for recording signals from the front **AV2** jacks.

RECEIVING/RECORDING STEREO/SAP BROADCASTS (MODEL 62 ONLY)

The Model 62 has three channels for audio recording — two (left and right) stereo channels on the Hi-Fi track, and one monaural channel on the standard track.

Press **DISP/ENT** to display the audio programs available on the broadcast you are currently tuned to. **STEREO**, **SAP**, and **MONO** appear. Parenthesis appear around each type of audio signal that is not available. For example, if a station broadcasts mono (monaural) and SAP signals, (**STEREO**), **SAP**, and **MONO** appear.

The arrow mark on the right of the audio mode display indicates the current audio mode. To select the audio mode when the broadcast has a stereo or SAP signal, press **SAP/Hi-Fi** so the arrow mark points to the desired mode.

IMMEDIATE RECORDING

Recording a Program as You Watch It

Follow these steps to record a program as you watch it. If you know how long the program is, you can set how long the VCR records so it stops recording automatically.

Note: If you are watching the program on a TV/monitor that is connected to the VCR's **AUDIO/VIDEO OUT** jacks, set the TV/monitor to the video mode and skip Steps 2 and 3.

1. Turn on the VCR and the TV.
2. Set the TV's tuner to the same channel as **3-CH-4** on the back of the VCR.
3. Press **TV/VCR** until VCR appears.
4. Load a blank cassette, or one that you want to record over, into the VCR.
5. Repeatedly press **SPEED** on the remote control until the desired recording speed (**SP**, **LP**, or **EP**) appears.
6. Select the signal to record (see "Selecting the Signal to Record").
7. (Model 62 only) Set the audio recording mode to the desired setting. See "Receiving/Recording Stereo/SAP Broadcasts (Model 62 Only)".
8. Press **REC/TIME**. The VCR starts to record and the following appears on the TV screen:

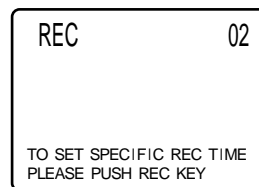

Note: To record without a set duration, skip Step 9.

9. Press **REC/TIME** again. The recording length appears on the TV screen. Repeatedly press **REC/TIME** to advance the timer to the desired recording length. The recording length advances in 30-minute increments up to 2 hours, then in 1-hour increments up to 4 hours.

Notes:

- To ensure that you record the entire program, set the recording length longer than the program length.
- To display the remaining recording time, press **DISP/ENT** during a timed recording.
- To temporarily stop the tape during a recording, press **PAUSE**. Press **PAUSE** again to resume recording. If you leave the VCR paused for about 5 minutes, the VCR automatically stops.
- If the cassette's erase protection tab has been removed, the VCR displays **CHECK CASSETTE RECORD TAB** and ejects the cassette. Use another cassette, or place a piece of heavy plastic tape over the erase-protection tab hole.

10. Press **STOP** to stop recording at any time.

Recording One Program on the VCR While You Watch Another on the TV

1. Follow Steps 1–9 of "Recording a Program as You Watch It" on Page 28.
2. Repeatedly press **TV/VCR** until VCR disappears.

Note: If you are watching the program on a TV/monitor that is connected to the VCR's **AUDIO/VIDEO OUT** jacks, set the TV/monitor to the TV mode.

3. Set the TV tuner to the channel you want to watch.
4. Press **STOP** to stop recording at any time.

AUTOMATIC TIMER RECORDING

The VCR's automatic timer lets you program it to select an input source, start recording from that source at a time you set, then stop recording at a time you set. You can set up to eight timers to record any combination of weekly, daily, or one-time events.

You can set the VCR to record at any time on a specific day within a 1-month period, at the same time Monday through Friday (DAILY), or at the same time on the same day every week (WEEKLY).

Notes:

- The VCR can record only one broadcast at a time. If you set the VCR's timer to record broadcasts on different channels that start at the same time, the VCR only records the broadcast that has the lowest timer number (see "Checking/Changing Timers" on Page 31).
- If two timer settings overlap, the one that starts first has priority. The VCR begins recording the second broadcast after the set time for the first broadcast is over.
- The VCR must be off at the start time you set for it to begin an automatic timer recording.
- If there is a power failure of more than 30 minutes during a timer recording, the recording does not resume after power is restored.
- If there is a power failure of more than 30 minutes before a start time, the VCR loses the clock setting and therefore does not start automatic timer recording. However, if you have an EDS channel in your area and set the VCR to automatically set the clock from the EDS signal, the clock is reset within 10 minutes after power is restored, and the VCR records at the set time(s). See "Turning On Auto Clock Set" on Page 17.

Setting a Timer

Note: If you use a TV/monitor that is connected to the VCR's **AUDIO/VIDEO OUT** jacks, set the TV/monitor to the video mode and skip Steps 2 and 3.

1. Turn on the VCR and the TV.
2. Set the TV to the same channel as **3-CH-4** on the back of the VCR.
3. Repeatedly press **TV/VCR** until **VCR** appears.
4. (Model 62 only) Set the audio recording mode to the desired setting. See "Receiving/Recording Stereo/SAP Broadcasts (Model 62 Only)" on Page 28.
5. Load a blank cassette, or one that you want to record over, into the VCR.
6. Press **PROG** on the remote control. The timer setting menu appears on the TV screen.

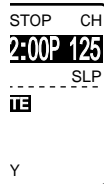

Or, if you have already entered timer settings, the current settings for up to the first four broadcasts appear.



Note: If the clock is not set, **PLEASE SET CLOCK BEFORE PROGRAMMING** appears, then the clock setting screen appears. Set the clock as described in "Manually Setting the Clock" on Page 16.

7. Repeatedly press **PLAY** or **STOP** to select an empty timer number, then press **FAST-F**. This menu appears.

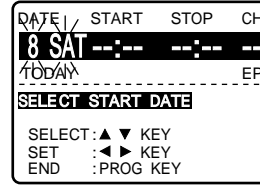

8. Repeatedly press **PLAY** or **STOP** to select the date when you want to record.

*To record a broadcast at the same time on the same day every week, press either button until **WEEKLY** flashes and the desired day of the week appears.*

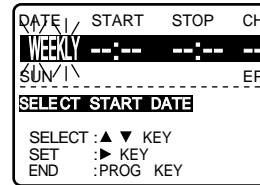

*To record a broadcast at the same time Monday through Friday, press either button until **DAILY** flashes and **MON-FRI** appears.*

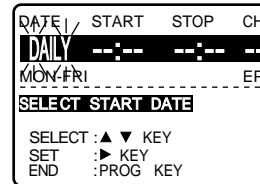

*To record a broadcast at a set time today, press either button until today's date flashes and **TODAY** appears.*

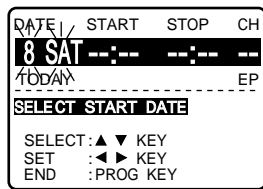

To record a broadcast at a specific time and date, repeatedly press **PLAY** or **STOP** to select the specific date.

Press **FAST-F** to store your selection.

9. Repeatedly press **PLAY** or **STOP** to select the start hour. When the correct hour appears, press **FAST-F**. Then repeatedly press **PLAY** or **STOP** to select the minute and press **FAST-F**.
10. Repeat Step 9 to set the end time.
11. Repeatedly press **PLAY** or **STOP** to select the channel.

To record from a source connected to the **AUDIO IN 1/VIDEO IN 1** (or **AV2** for the Model 62) jacks, repeatedly press **PLAY** or **STOP** until **LINE (LINE 1 or LINE 2)** on the Model 62) appears.

12. Repeatedly press **PLAY** or **STOP** to select the tape speed (**SP**, **LP**, or **EP**).
13. Double-check all the set information.
 - If the information is correct, press **PROG**.
 - If an entry is not correct, repeatedly press **FAST-F** or **REW** to move the cursor to the incorrect entry, enter the correct information, then press **PROG**.

The timer settings appear on the TV screen. To enter another setting, repeatedly press **PLAY** or **STOP** to select another timer number and repeat Steps 7–13.

14. Press **PROG** again. **TURN VCR OFF FOR TIMER RECORDING** briefly appears.
15. Press **POWER** to turn off the VCR. **TIMER** appears.

Notes:

- Be sure that **TIMER** appears when you turn the VCR off. If it does not appear, check your entries.
- If you load a cassette with its erase-protection tab removed and set the VCR's timer, the VCR ejects the cassette and flashes **TIMER**.
- If you set up the VCR to record a cable broadcast through a cable box, be sure to leave the cable box turned on and tuned to the desired station before the broadcast starts.
- You can manually turn on and operate the VCR before the set times, but the VCR starts an automatic timer recording only if the power is off at the set start time.

Monitoring an Automatic Timer Recording

1. Turn on the TV and set it to the same channel as **3-CH-4** on the back of the VCR.

Note: If you are using a TV/monitor that is connected to the VCR's **AUDIO/VIDEO OUT** jacks, set the TV/monitor to the video mode.

2. Press **TV/VCR** until VCR appears.

Checking/Changing Timers

1. Turn on the TV and set it to the same channel as **3-CH-4** on the back of the VCR.

Note: If you are using a TV/monitor that is connected to the VCR's **AUDIO/VIDEO OUT** jacks, set the TV/monitor to the video mode.

2. Turn on the VCR and repeatedly press **TV/VCR** until VCR appears.
3. Press **PROG**. The first four timer settings appear.

STOP	CH	SPD
2:00A	08	SP

4. Repeatedly press **PLAY** or **STOP** to select the setting you want to change, then press **FAST-F**.
5. Follow Steps 8–12 under “Setting a Timer” on Page 30 to correct the selected setting.
6. When you finish, press **PROG** again, then turn off the VCR.

Clearing a Timer

If the timer recording has not yet started:

1. Follow Steps 1–3 under “Checking/Changing Timers.”
2. Highlight the setting you want to clear, then press **ADD/HLT**.
3. When you finish clearing the timer, press **PROG**.

Turn off the VCR if you still have at least one timer setting entered.

If a timer recording is in progress:

1. Press **POWER** to stop timer recording. **TO CANCEL TIMER REC PUSH POWER THEN STOP KEY** appears if you are watching the signal from the VCR.
2. Within 10 seconds, press **STOP**. **TIMER** disappears.

DUBBING

The process of recording from one audio/video device to another is called dubbing.

An audio/video device where a signal originates is called the dubbing source. You can use another VCR, camcorder, satellite receiver, or other device with A/V outputs as the dubbing source, connect the dubbing source and the VCR, then use your VCR to record the signal from the dubbing source.

Or, you can use this VCR as the dubbing source for another VCR. See “Installation” on Page 9 for the various possible connections.

Notes:

- Always use video-quality shielded cables with phono-type connectors to connect the device to the VCR. Do not use standard audio patch cords.
- Most material performed in public, such as concerts, plays, and movies, or distributed on prerecorded video tapes is copyrighted. The unauthorized recording or duplication of copyrighted material is a violation of the copyright laws of most countries and such duplication may result in fines, imprisonment, or both. Note, however, that in the United States, it is not a violation of U.S. copyright laws for a consumer to record a broadcast television program for private (in-home) viewing.

To dub a tape, start playback on the dubbing source first (see that device’s instructions) then start recording on the recording VCR.

AUDIO-ONLY RECORDING (MODEL 62 ONLY)

Because of the superior quality of VHS Hi-Fi audio recordings, you might want to use your VCR as an audio-only recorder. You can also make live recordings by connecting a pre-amplifier or mixer to the VCR's **AUDIO IN** jacks. Simply select the line input and record as usual.

Caution: Do not directly connect a microphone to the VCR.

Note: For the best audio fidelity, we recommend you use high-quality video tape (such as Cat. No. 44-410) to make audio-only recordings.

ADDITIONAL INFORMATION

TROUBLESHOOTING

If you follow the instructions in this manual and still have trouble operating your VCR, look in this chart for the problem description and its solution. If your VCR still does not work properly, contact your local RadioShack store.

PROBLEM	POSSIBLE SOLUTION
No power.	The power cord is not connected. Plug the power cord into an AC outlet.
Timer recording did not work, or a broadcast was recorded at the wrong time.	<ul style="list-style-type: none"> The power is on. Turn off the power. The timer is not set or is set incorrectly. Check the timer settings.
Cannot record.	The erase-protection tab is missing. Place a piece of tape over the tab hole.
Picture is poor on playback.	<ul style="list-style-type: none"> The TV is not set to the proper channel. Set the TV to Channel 3 or 4. The TV's fine tuning is not set correctly. Fine tune your TV. Audio/video connections are incorrect. Check all connections.
The playback picture is distorted.	<ul style="list-style-type: none"> The video heads are dirty. See "Cleaning the Video Heads" on Page 37. The VCR might not have adjusted the tracking correctly. You might need to manually adjust the tracking (see "Tracking" on Page 26).
No picture on playback.	<ul style="list-style-type: none"> The TV is not set to the proper channel. Set it to Channel 3 or 4, or to its audio/video input if you connected it to the VCR's AUDIO/VIDEO OUT jacks. Audio/video connections are incorrect. Check all connections.
Remote control buttons do not work when the power is on and a cassette is loaded.	<ul style="list-style-type: none"> Something is blocking the path from the remote control to the VCR. Bright light is shining on the VCR's remote control sensor window. Get closer to the VCR, or change the VCR's location. The remote control might be set for another device's operation. Try pressing VCR. The remote control's batteries might be weak. Replace the batteries.
Cannot see broadcast TV programs using the VCR's tuner.	<ul style="list-style-type: none"> TV/VCR is not set correctly. Repeatedly press TV/VCR until VCR appears. Audio/video connections are incorrect. Check all connections.
Cannot record from the input jacks.	<ul style="list-style-type: none"> Connections are incorrect. Check all connections. INPUT is not set correctly. Select LINE (LINE 1 or LINE 2 for the Model 62).

PROBLEM	POSSIBLE SOLUTION
No stereo sound for a stereo recording (Model 62 only).	<ul style="list-style-type: none">• You have not connected the VCR's AUDIO OUT jacks to a stereo system or stereo TV. Connect the jacks to a stereo output.• The audio out setting is not correctly set. Set it to Hi-Fi (see "Receiving/Recording Stereo/SAP Broadcasts (Model 62 Only)" on Page 28).• The VCR might not have adjusted the tracking correctly. You might need to manually adjust the tracking (see "Tracking" on Page 26).

CARE AND MAINTENANCE

Your Optimus 4-Head VHS HQ VCR is an example of superior design and craftsmanship. The following suggestions will help you care for your VCR so you can enjoy it for years.



Keep the VCR dry. If it gets wet, wipe it dry immediately. Liquids might contain minerals that can corrode the electronic circuits.



Use and store the VCR only in normal temperature environments. Temperature extremes can shorten the life of electronic devices and distort or melt plastic parts.



Keep the VCR away from dust and dirt, which can cause premature wear of parts.



Handle the VCR gently and carefully. Dropping it can damage circuit boards and cases and can cause the VCR to work improperly.



Use only fresh batteries of the required size and type in the remote control. Batteries can leak chemicals that damage your VCR remote control's electronic parts.



Wipe the VCR with a damp cloth occasionally to keep it looking new. Do not use harsh chemicals, cleaning solvents, or strong detergents to clean the VCR.

Modifying or tampering with the VCR's internal components can cause a malfunction, invalidating your VCR's warranty and voiding your FCC authorization to operate it. If your VCR is not performing as it should, take it to your local RadioShack store for assistance.

Servicing Your VCR

There are no user-serviceable parts inside your VCR. If you encounter a problem that you cannot correct using this manual and its troubleshooting guide, take the VCR to your local RadioShack store for assistance.

Cleaning the Video Heads

When video head cleaning becomes necessary, the VCR displays the following message on the TV screen while playing back a recorded tape.

Video head cleaning kits are available from your local RadioShack store. Clean the heads only when the VCR displays the message shown above. Be sure to use the "dry" type cleaning cassette.

Serious problems require cleaning by a trained technician. For more head cleaning information, contact your local RadioShack store.

Storing Your Video Cassettes

Unless you are making an automatic timer recording, eject and store the cassette before you turn off the VCR. This helps protect the cassette and the VCR's internal mechanisms.

Place your video cassettes in their protective boxes and store them in a cool, dry, dust-free environment. Store the cassettes on end, not on their sides, to prevent improper settling of the cassette's spools.

Note: Tape can become wound too tightly around the cassette's spools after many playings. This can make the cassette load improperly and automatically eject when you insert it. On most cassettes there is a brake-release plunger on the bottom center of the cassette. Use the tip of a pen or pencil to press the plunger. This loosens the tape.

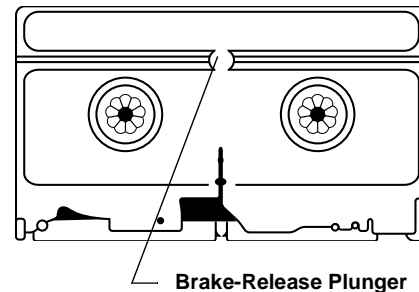

SPECIFICATIONS

Television System	NTSC Standard Color Signal
Recording System	Four-Head Double Azimuth
Tape Width	1/2 Inch
Tape Speed:	
SP	1.31 Inch/second (33.35 mm/s)
LP	0.65 Inch/second (16.67 mm/s)
EP	0.43 Inch/second (11.12 mm/s)
Tuner Channels:	
VHF	2-13
UHF	14-69
CATV	1-125
RF Converter	Built-in VHF Converter
Converter Output	Channel 3 or 4
Terminals:	
Antenna Input	VHF/UHF: F Type
Antenna Output	VHF/UHF: F Type
Video Input/Output	Phono Connector
Audio Input/Output	Phono Connector
Video Output Level	1.0 V _{p-p}
Video Output Impedance	75 Ω
Audio Output Level	-8 dBV
Audio Output Impedance	1 kΩ
Video Input Level	0.5-2.0 V _{p-p}
Video Input Impedance	50 kΩ
Audio Input Level	-10 dBV
Audio Input Impedance	47 kΩ
Video S/N Ratio (weighted):	
SP	42 dB
EP	40 dB
Audio S/N Ratio:	
Regular Audio (weighted)	
SP	43 dB
EP	40 dB
Hi-Fi Audio (Model 62 only) (Dynamic Range):	
SP	More than 90 dB
LP	More than 90 dB
EP	More than 90 dB

Frequency Response:

Regular Audio

SP 80 Hz–10 kHz

EP 80 Hz–5 kHz

Hi-Fi Audio (Model 62 only) In All Modes 20 Hz–20 kHz

Power Requirement 120 V, 60 Hz

Power Consumption

Models 112/113 18 Watts

Model 62 23 Watts

Dimensions (HWD) $3\frac{5}{8} \times 14\frac{15}{16} \times 11\frac{13}{16}$ Inches ($9.3 \times 38 \times 30$ cm)

Weight 7 lbs 6 oz (3.4 kg)

Specifications are typical; individual units might vary. Specifications are subject to change and improvement without notice.

Limited Ninety-Day Warranty

This product is warranted by RadioShack against manufacturing defects in material and workmanship under normal use for ninety (90) days from the date of purchase from RadioShack company-owned stores and authorized RadioShack franchisees and dealers. EXCEPT AS PROVIDED HEREIN, RadioShack MAKES NO EXPRESS WARRANTIES AND ANY IMPLIED WARRANTIES, INCLUDING THOSE OF MERCHANTABILITY AND FITNESS FOR A PARTICULAR PURPOSE, ARE LIMITED IN DURATION TO THE DURATION OF THE WRITTEN LIMITED WARRANTIES CONTAINED HEREIN. EXCEPT AS PROVIDED HEREIN, RadioShack SHALL HAVE NO LIABILITY OR RESPONSIBILITY TO CUSTOMER OR ANY OTHER PERSON OR ENTITY WITH RESPECT TO ANY LIABILITY, LOSS OR DAMAGE CAUSED DIRECTLY OR INDIRECTLY BY USE OR PERFORMANCE OF THE PRODUCT OR ARISING OUT OF ANY BREACH OF THIS WARRANTY, INCLUDING, BUT NOT LIMITED TO, ANY DAMAGES RESULTING FROM INCONVENIENCE, LOSS OF TIME, DATA, PROPERTY, REVENUE, OR PROFIT OR ANY INDIRECT, SPECIAL, INCIDENTAL, OR CONSEQUENTIAL DAMAGES, EVEN IF RadioShack HAS BEEN ADVISED OF THE POSSIBILITY OF SUCH DAMAGES.

Some states do not allow the limitations on how long an implied warranty lasts or the exclusion of incidental or consequential damages, so the above limitations or exclusions may not apply to you.

In the event of a product defect during the warranty period, take the product and the RadioShack sales receipt as proof of purchase date to any RadioShack store. RadioShack will, at its option, unless otherwise provided by law: (a) correct the defect by product repair without charge for parts and labor; (b) replace the product with one of the same or similar design; or (c) refund the purchase price. All replaced parts and products, and products on which a refund is made, become the property of RadioShack. New or reconditioned parts and products may be used in the performance of warranty service. Repaired or replaced parts and products are warranted for the remainder of the original warranty period. You will be charged for repair or replacement of the product made after the expiration of the warranty period.

This warranty does not cover: (a) damage or failure caused by or attributable to acts of God, abuse, accident, misuse, improper or abnormal usage, failure to follow instructions, improper installation or maintenance, alteration, lightning or other incidence of excess voltage or current; (b) any repairs other than those provided by a RadioShack Authorized Service Facility; (c) consumables such as fuses or batteries; (d) cosmetic damage; (e) transportation, shipping or insurance costs; or (f) costs of product removal, installation, set-up service adjustment or reinstallation.

This warranty gives you specific legal rights, and you may also have other rights which vary from state to state.

RadioShack Customer Relations, Dept. W, 100 Throckmorton St., Suite 600, Fort Worth, TX 76102

We Service What We Sell

3/97

RadioShack
A Division of Tandy Corporation
Fort Worth, Texas 76102